

# A VISIT TO

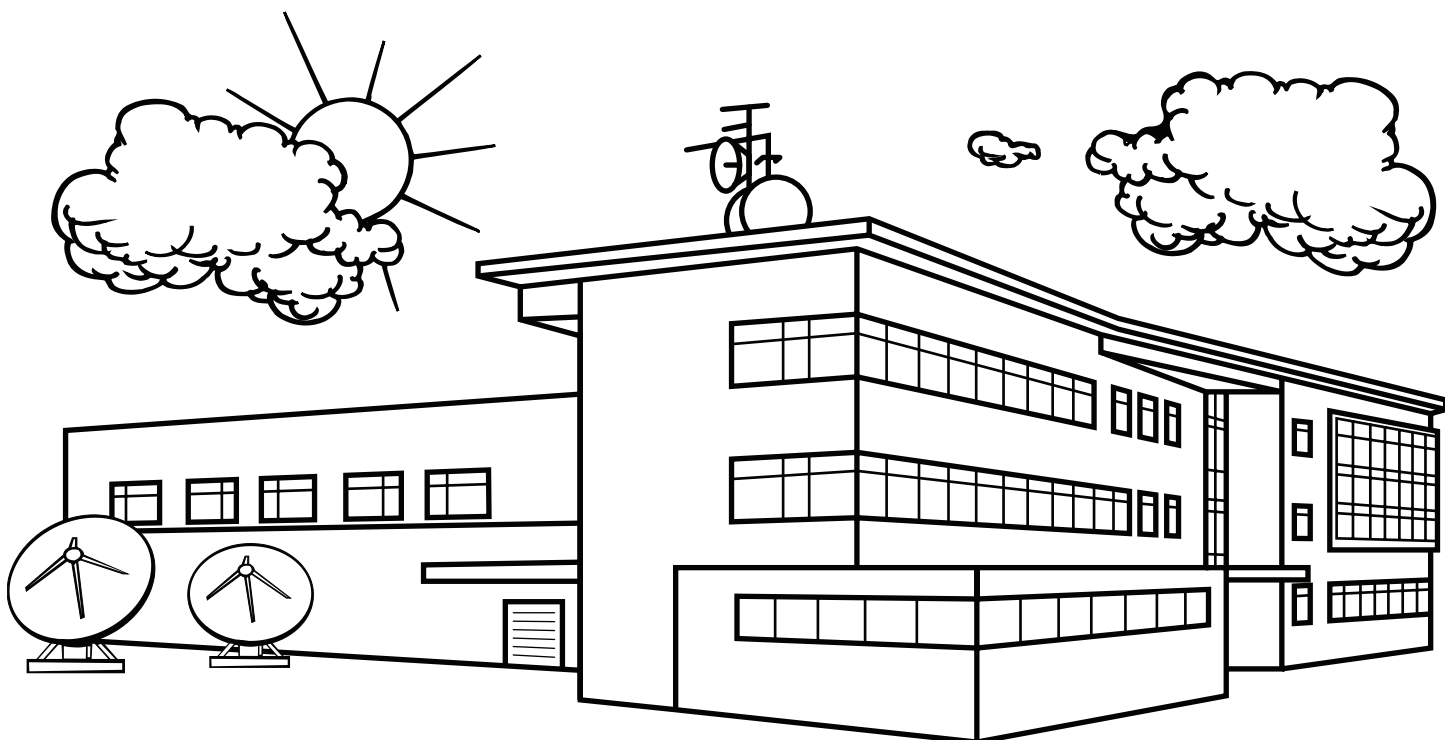

# WPSU

Here is a map that shows where the WPSU studio is located in Pennsylvania. Inside the oval shape is where you can find all the houses with TVs that can get WPSU. Draw where your house is in the oval.

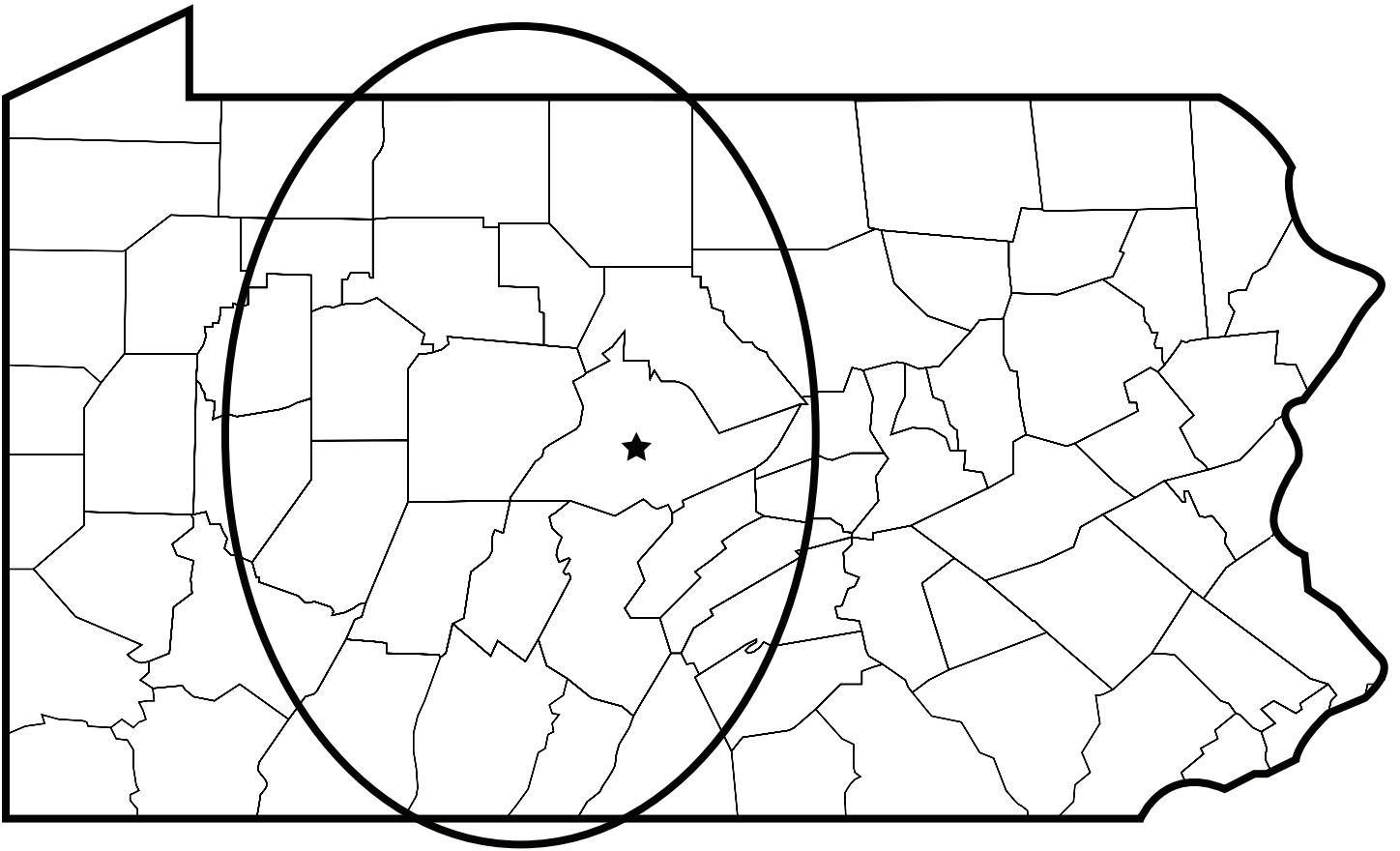

**WPSU** ★ University Park, PA

**WOW! There are so many pieces in the television studio! When pieces are put together, they are called SETS.**

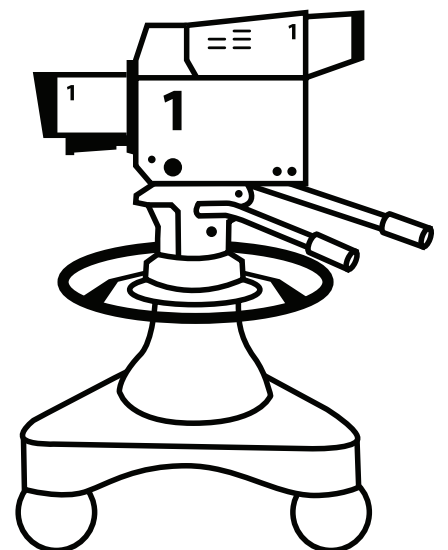
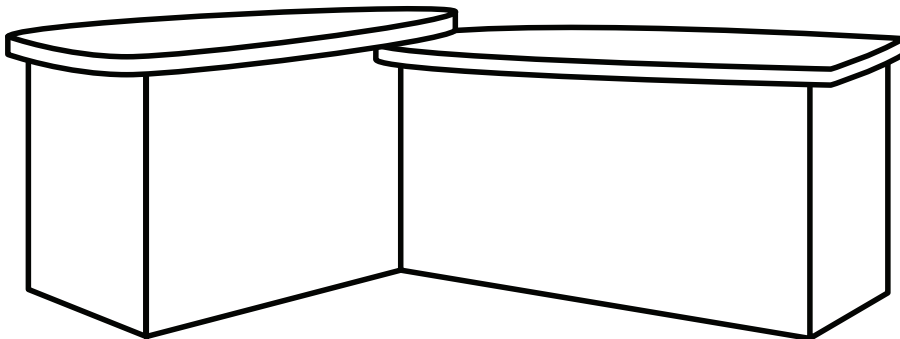
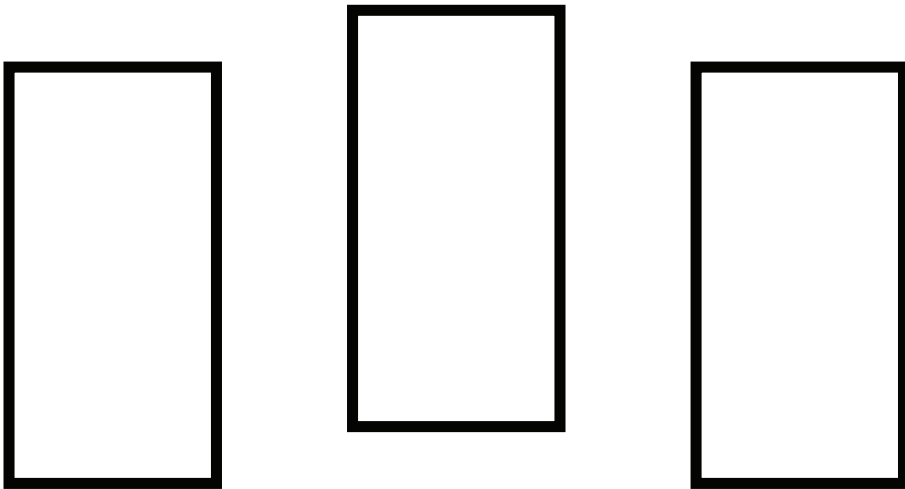
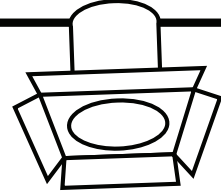
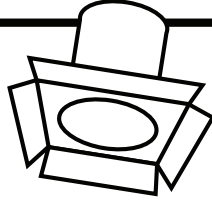
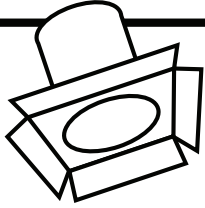

This set is for a WPSU show called *Pennsylvania Inside/Out*. How many rectangles do you see? How many circles do you see?

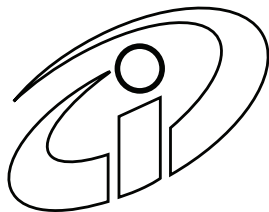
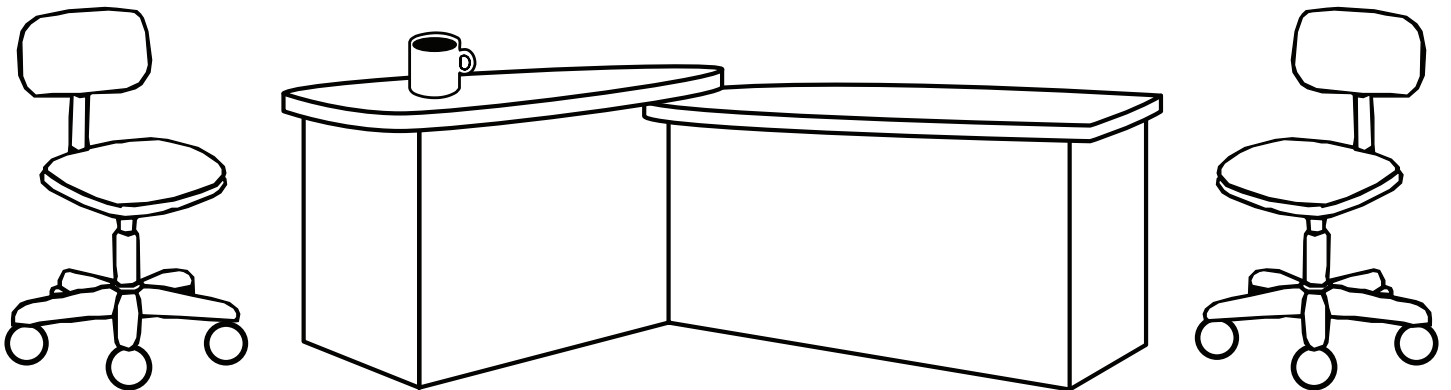
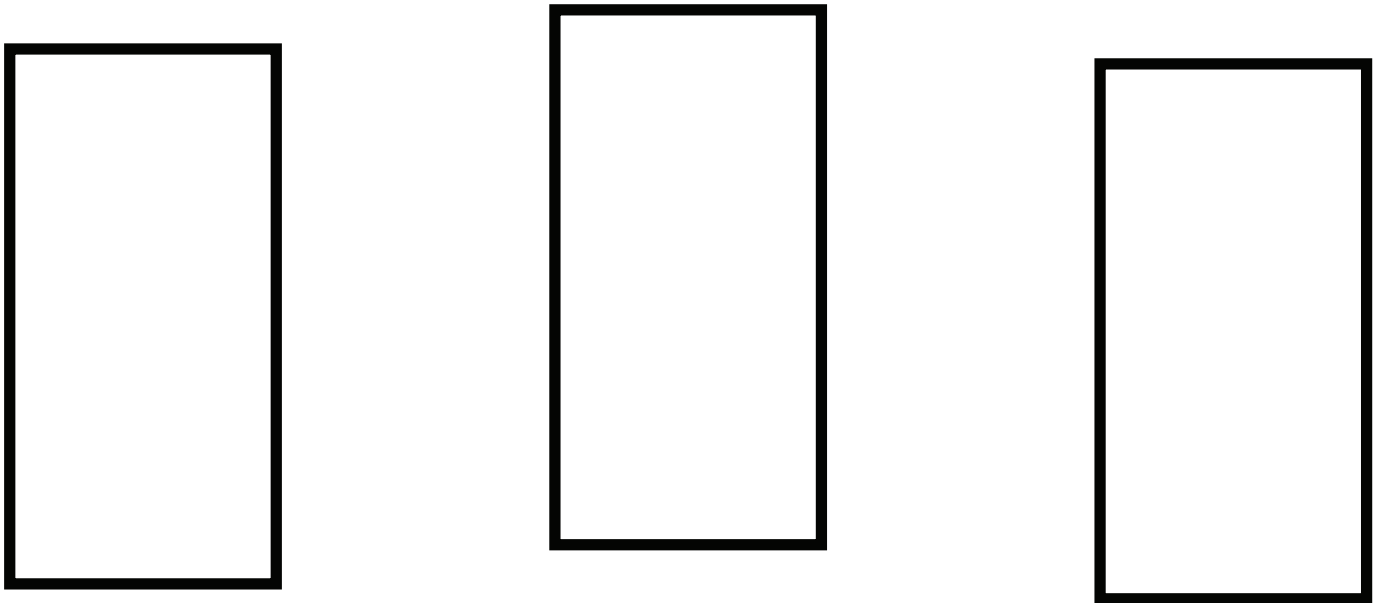

This is the set for *Scholastic Scrimmage*. Draw your school's team behind the set.

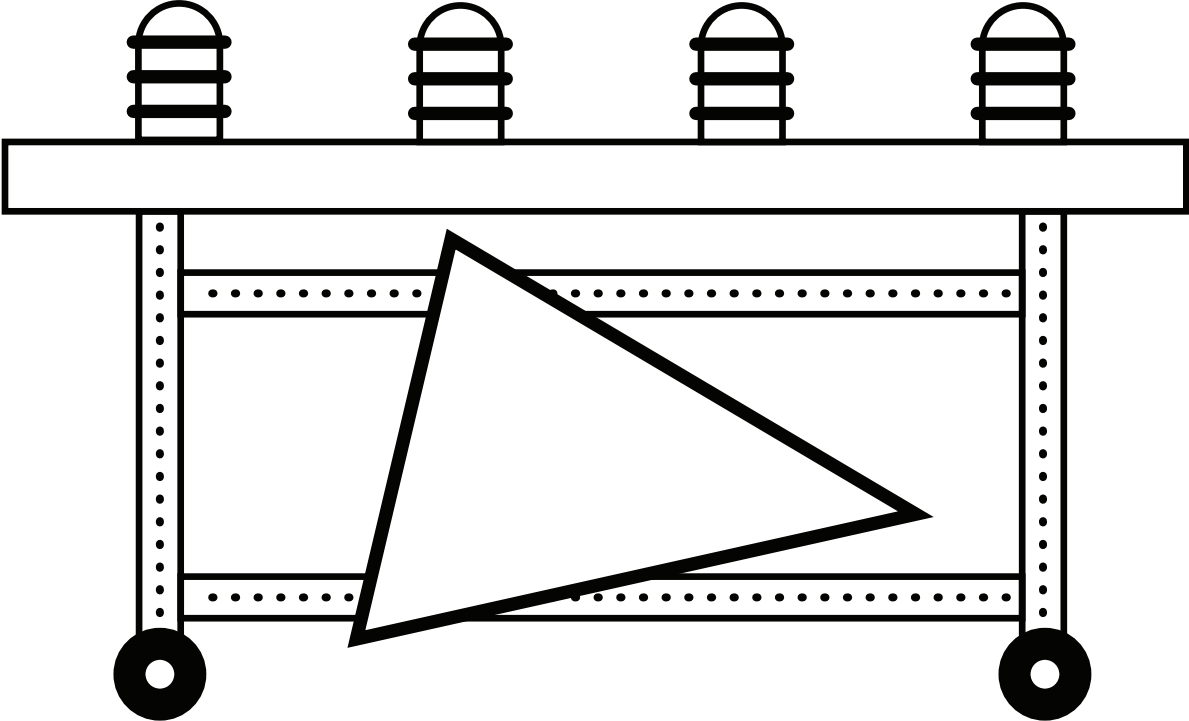
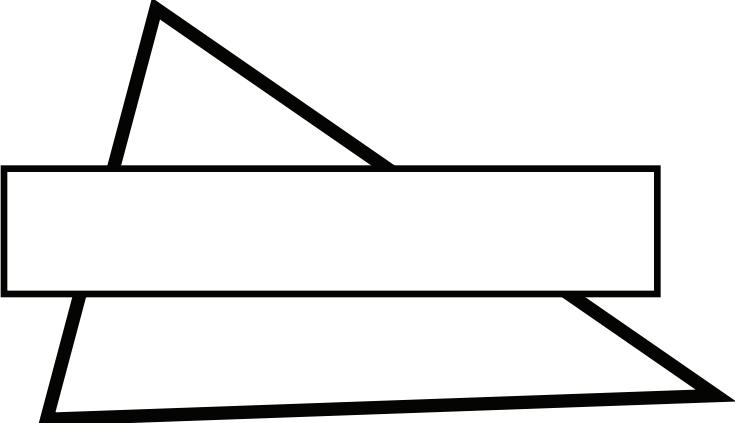

At WPSU-TV we have special times of the year called PLEDGE. During this time there are special programs, like cooking shows. Read the recipe and circle which ingredients the host needs to make a tasty sandwich.

## RECIPE

- 2 slices of bread
- peanut butter
- jelly

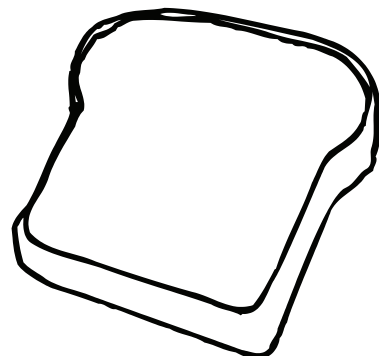
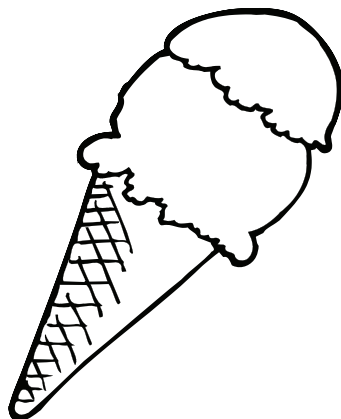
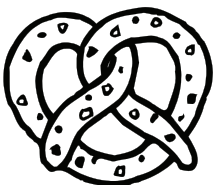
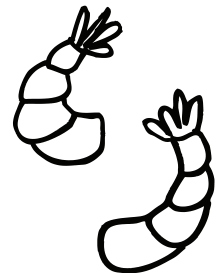
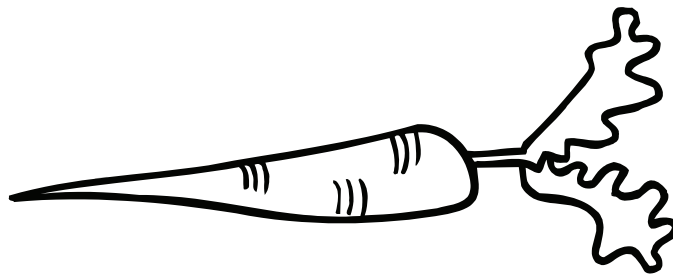
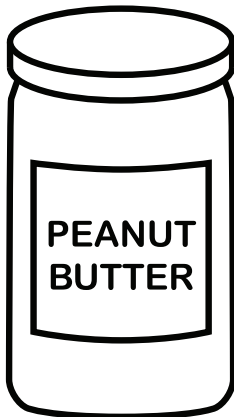
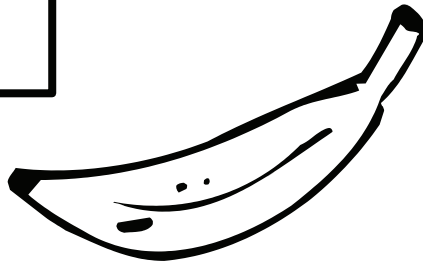
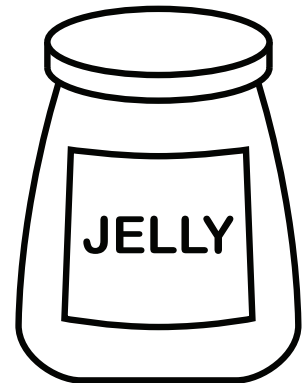
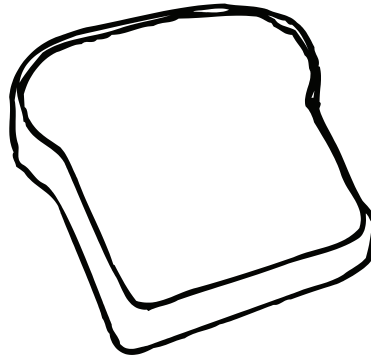

The **GREEN ROOM** is where guests wait before they go on TV. Decorate the **GREEN ROOM** however you wish.

**HINT:** It doesn't have to be green!

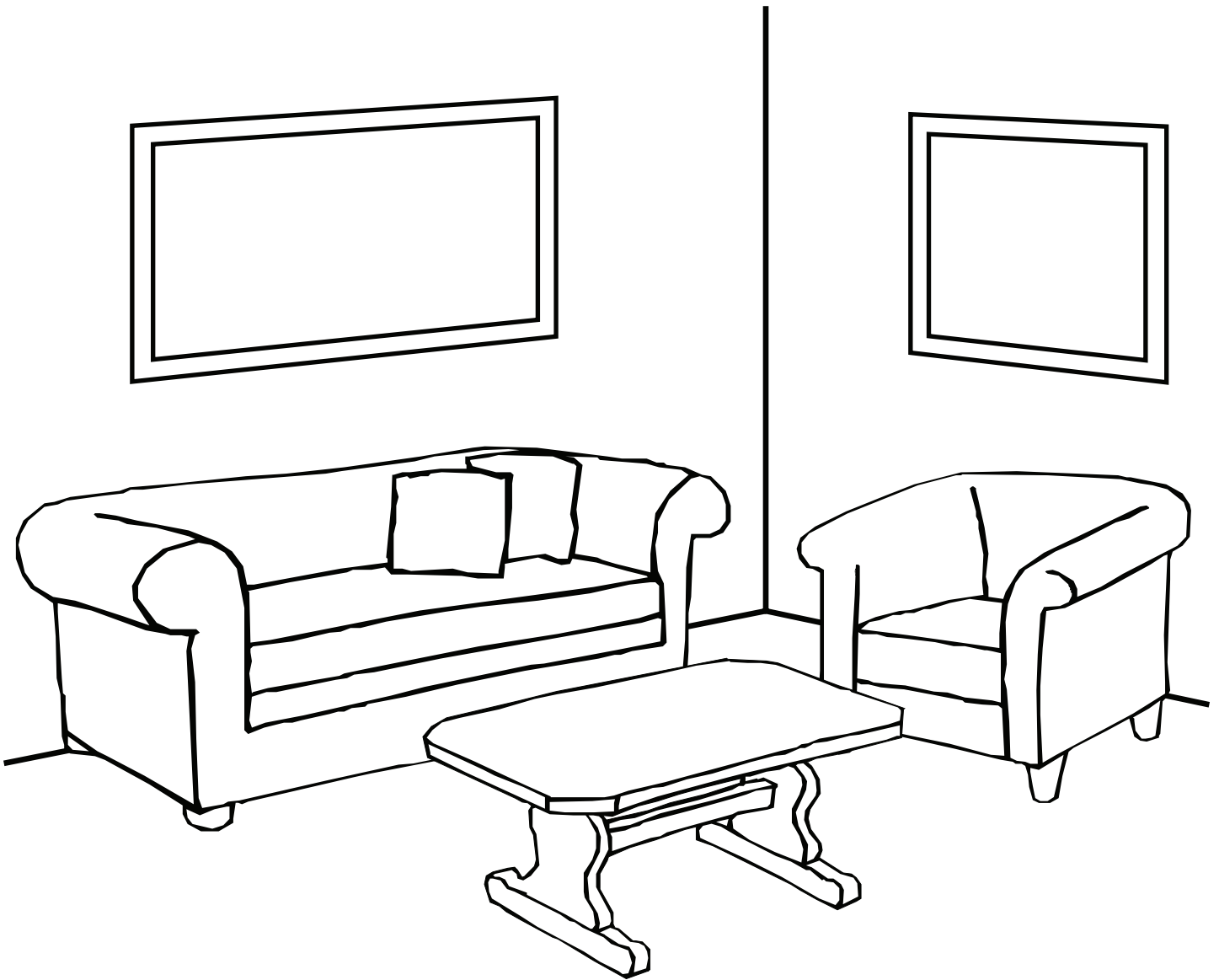

**GELS are used in the TV studio to make the lights shine in different colors. What happens when 2 GEL colors are mixed together?**

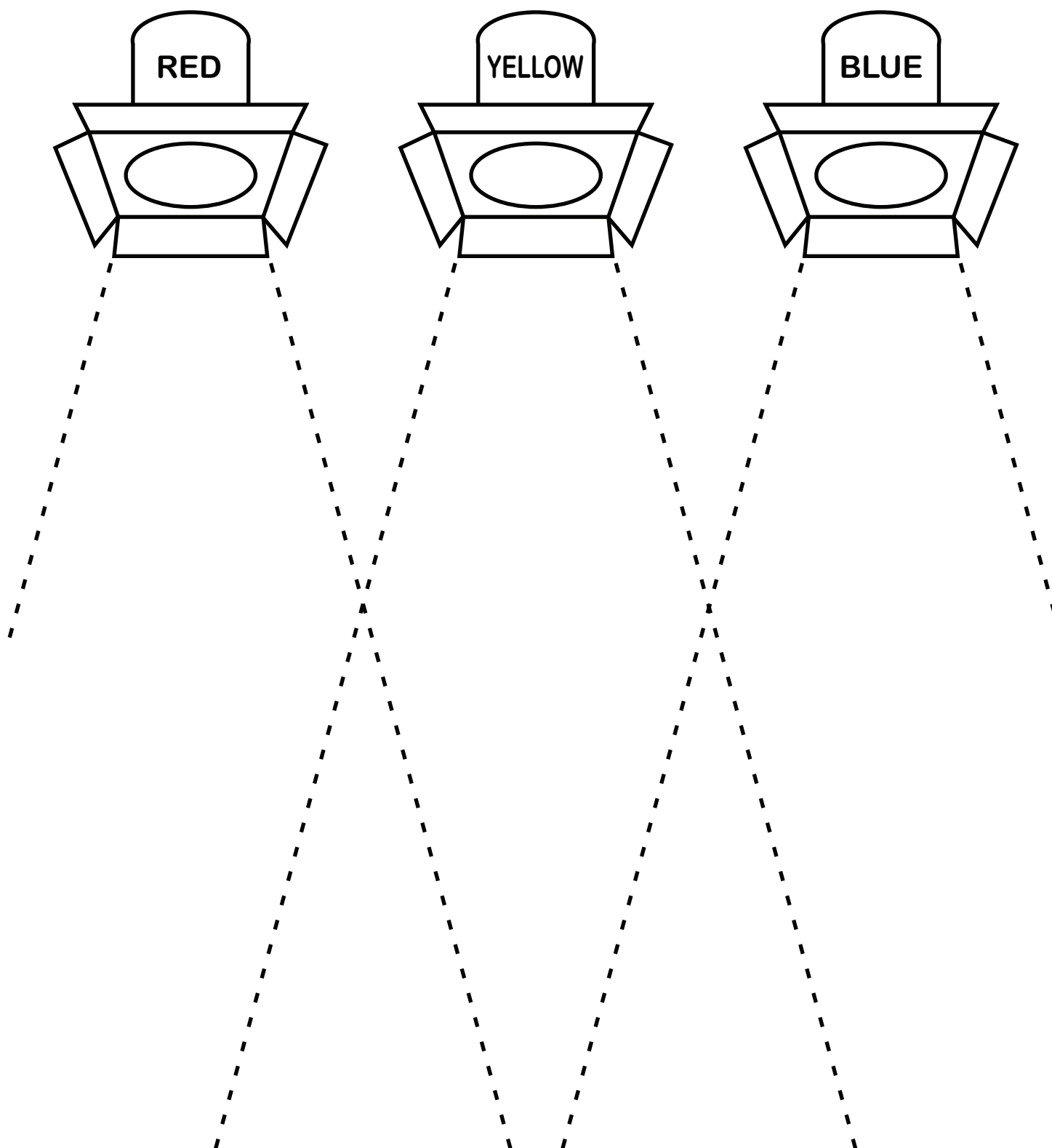

This is a TV CAMERA. The CAMERA sees whatever it is pointed toward. Then it sends that picture to your TV at home. Draw what this CAMERA sees.

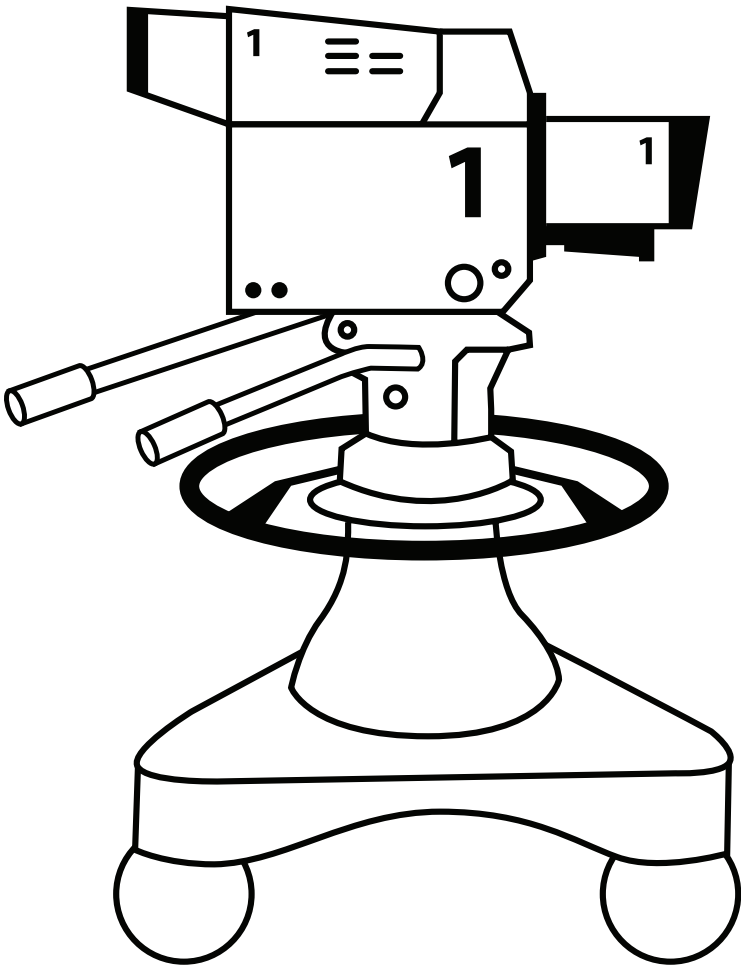

At WPSU we have a TV and a RADIO (FM) station.  
Can you find your way through the maze from the  
TV studio to the RADIO (FM) studio?

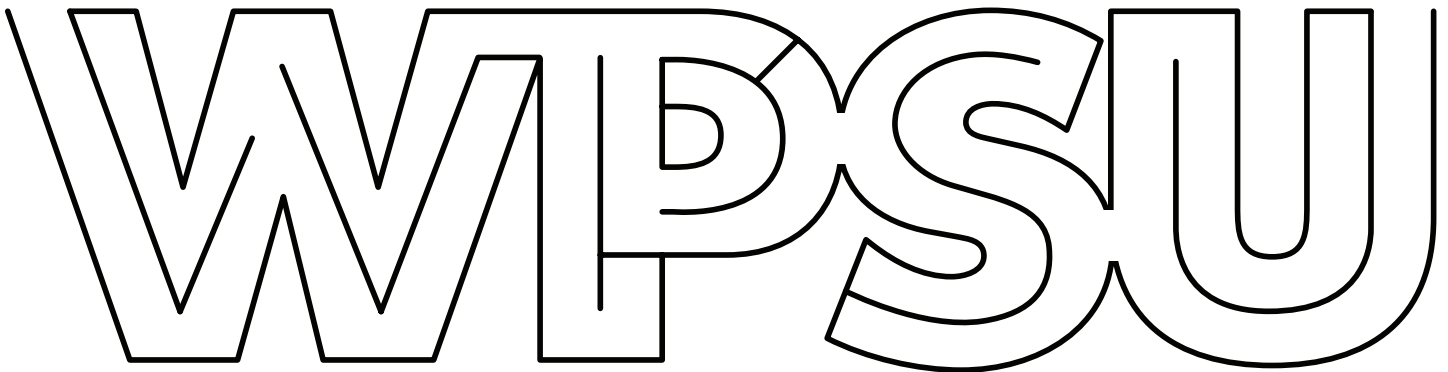

This is where WPSU-FM is found. Find all 5 hidden letters in the picture. Unscramble them to make the word RADIO.

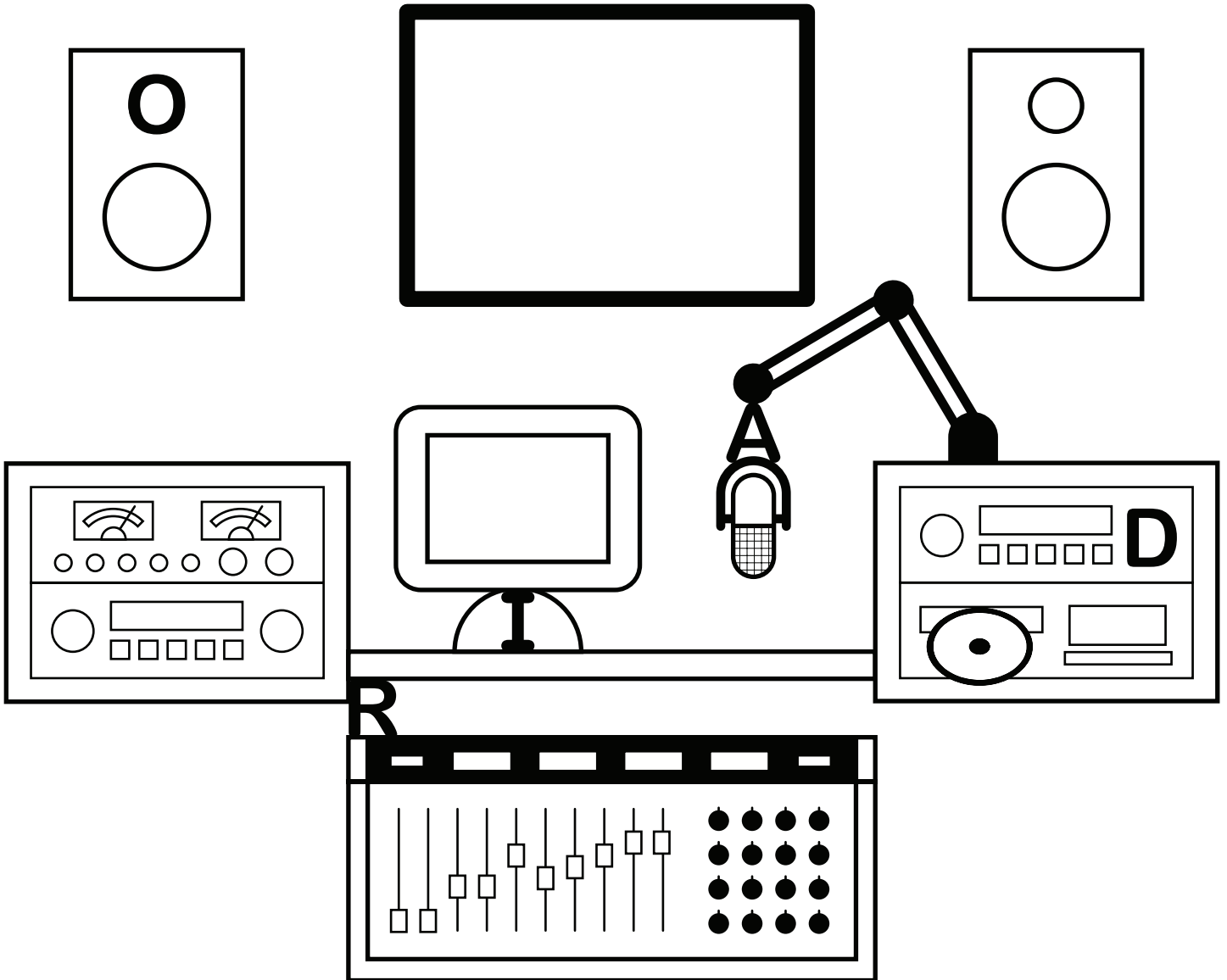

Not everything that you see on WPSU-TV and hear on WPSU-FM comes from our station. Outside the station are **SATELLITE DISHES** that receive signals. The signals deliver programs to WPSU.

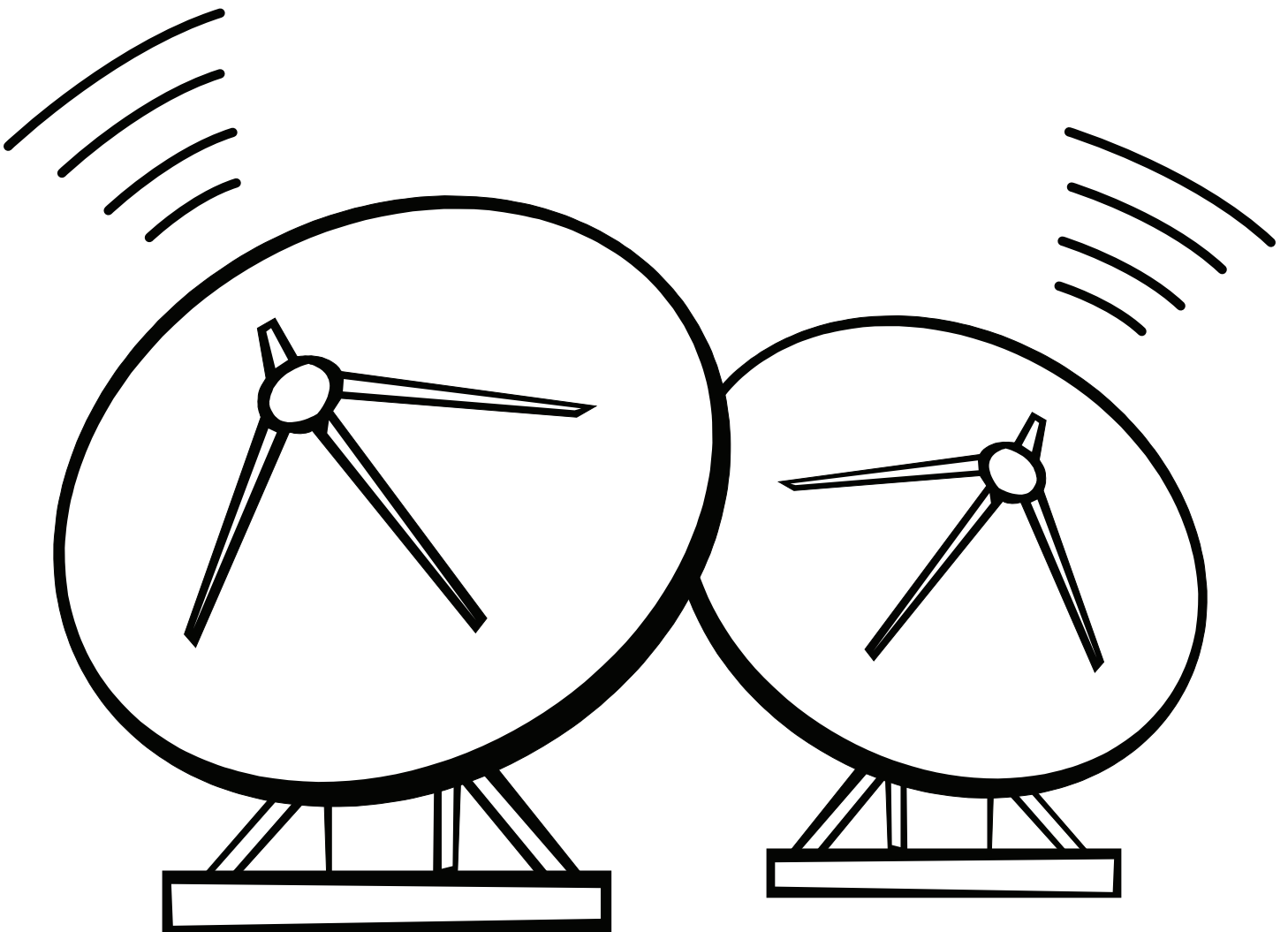

The signals from the satellite dishes, along with the programs made at WPSU, are sent to a **TRANSMITTER** on a mountain—

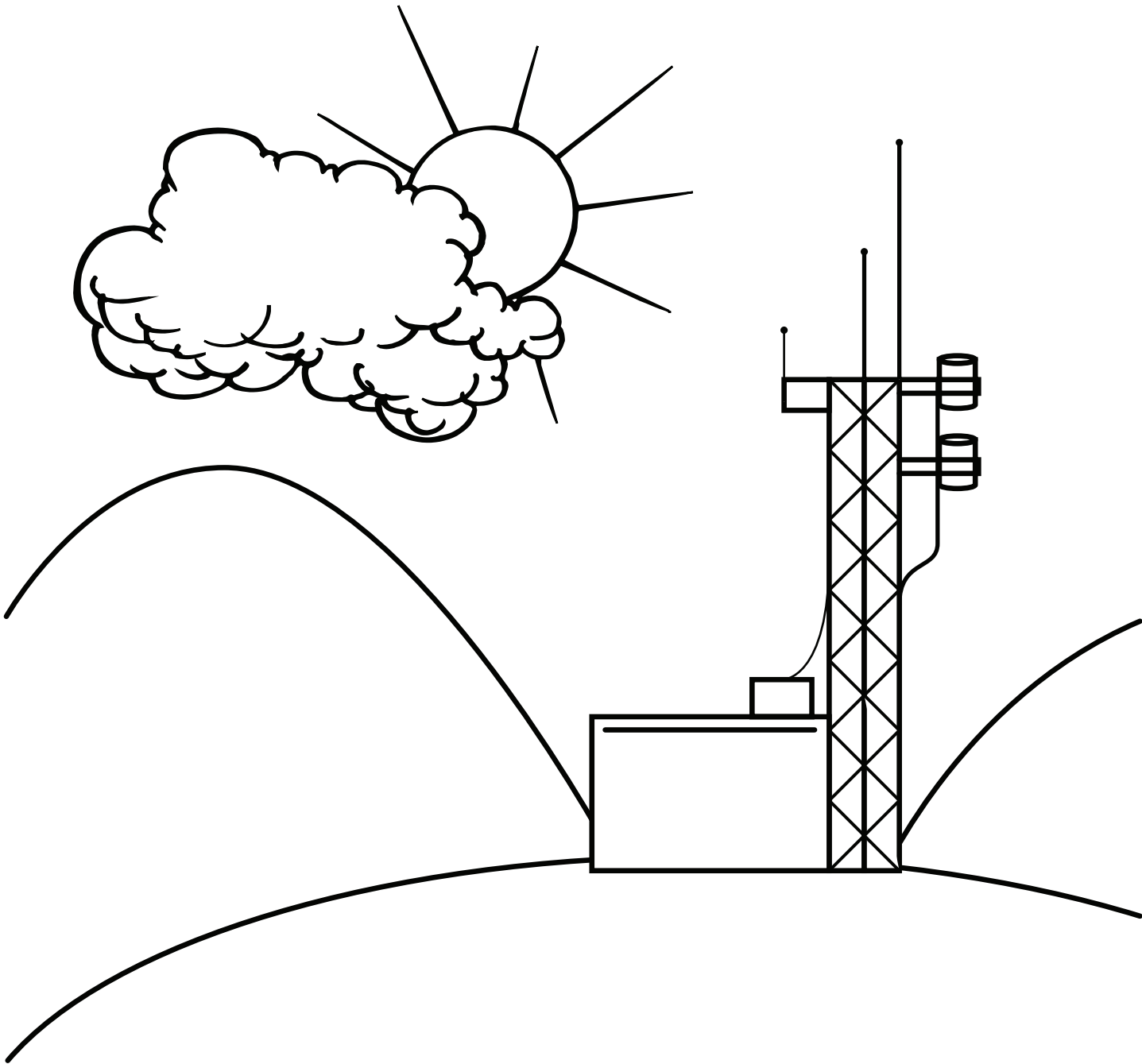

where they are sent to your house. You can draw your favorite PBS show in this TV set.

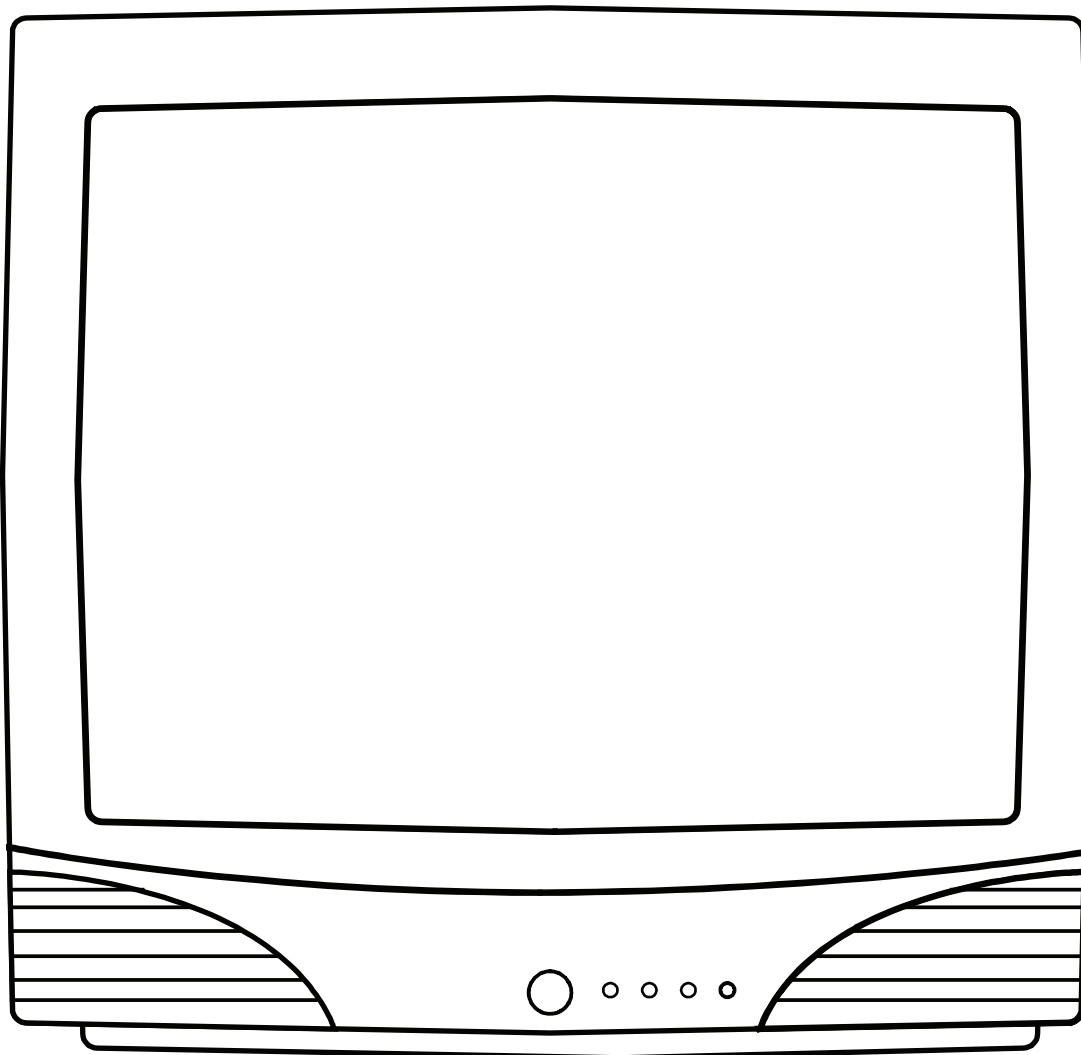

Thank you for visiting WPSU. We hope to see you again soon!

# VOCABULARY

**GELS**—Pieces of colored plastic that make lights on the set shine in different colors

**GREEN ROOM**—The room where guests for WPSU programs wait until it is their turn to be in the studio

**PLEDGE**—Times during the year when people in the community are asked to help WPSU by promising to donate money to pay for programs that air on WPSU

**SATELLITE DISH**—A large antenna shaped like a bowl that can either send out signals or receive signals

**SET**—The place in the studio where a program is filmed

**SIGNAL**—Invisible waves that move through the air, carrying information

**TRANSMITTER**—The tower on top of the mountain that sends the signals to houses in the WPSU viewing area

**Dear Parents and Educators,**

**At WPSU we understand the value of quality, educational programs. The philosophy that education can be entertaining, interactive, and meaningful for our audiences is not just applied to what is aired on television or radio, but to everything we do. Through our Educational Services division, we are constantly aiming to create teachable moments and to instill a lifelong love for learning in our youngest, most impressionable audiences. This can happen in the form of television programs, station events, or even with something as simple as what you hold in your hand: a child's coloring book.**

**We hope that this coloring book will provide you with another opportunity to spend time with the child in your life—exploring, learning, and sharing together. The design of this coloring book aligns with Pennsylvania Academic Standards for both pre-K and kindergarten children, to help meet their educational needs that are so important for lifelong academic success.**

**For more information on Educational Services or any of our other programs at WPSU, please do not hesitate to contact us at 814-865-3333.**

**Thank you for supporting public broadcasting.**

**The WPSU Educational Services Team**

**\*Applicable Pennsylvania Academic Standards are available on our Web site: <http://www.wpsu.org/3to8>.**